

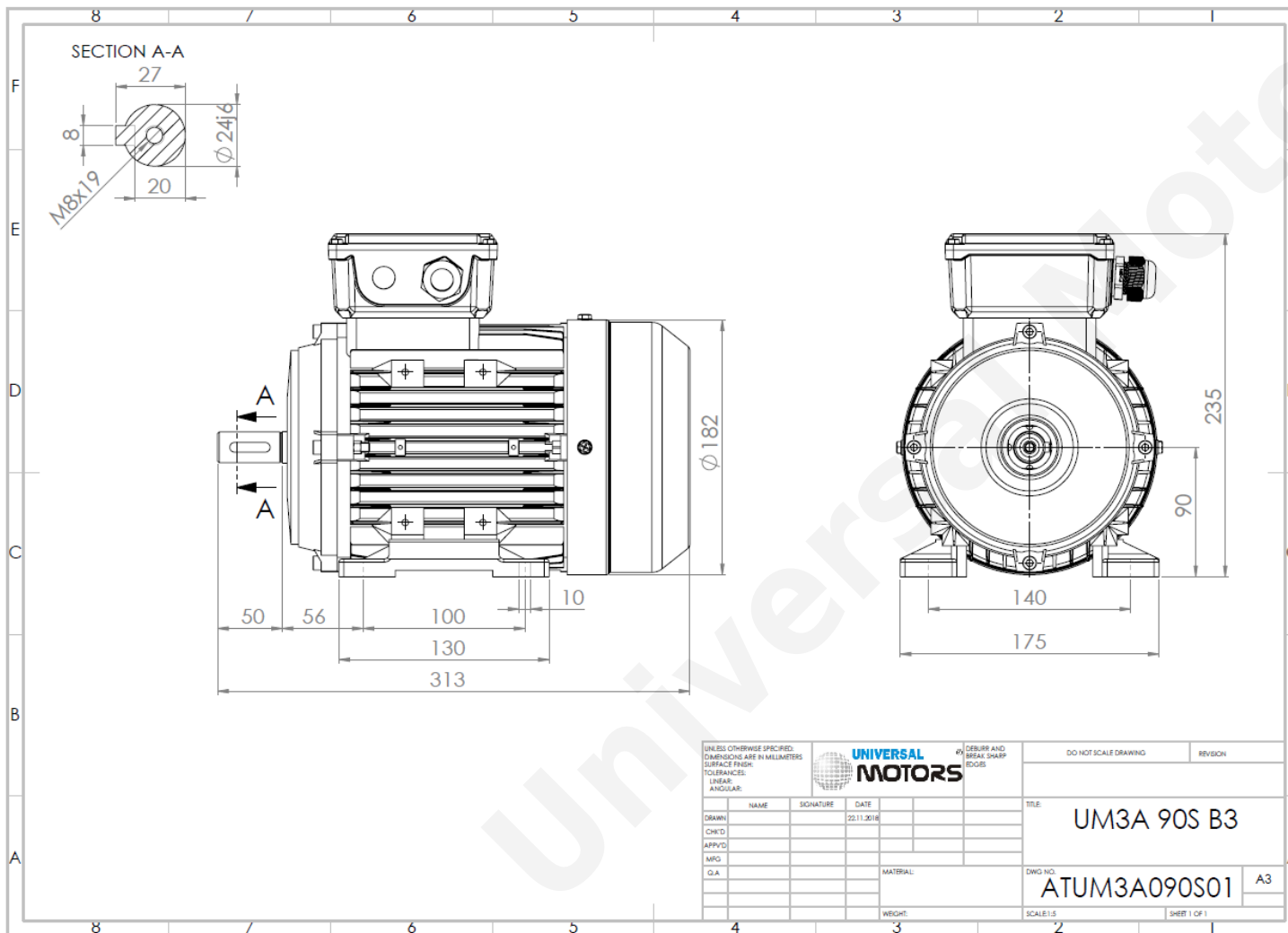

TECHNICAL DATA

Three Phase Electric Motors - Aluminum Frame
 PE31 90S-6
 0.75 kW / 1.0 Cv
 945 RPM



Motor type:	PE31 90S-6
Output:	0.75 kW / 1.0 Cv
Speed (min ⁻¹):	945 RPM
Frequency:	50 Hz
Voltage:	400 V
Current:	1.9 A
Power factor (Cos Ø):	0.72
Poles:	6
Insulation class:	F
Temperature rise Class:	B
Efficiency 50%:	76.9 %
Efficiency 75%:	80.1 %
Efficiency 100%:	78.9 %
Torque:	7.6 N.m
Tstarting/Tnominal:	2.1
Istarting/Inominal:	5.8
Tmaximum/Tnominal:	2.1
Noise:	63 Db(A)
Weight:	13.0 Kg
Bearing DE:	6205 2Z C3
Bearing NDE:	6204 2Z C3

Regime - S1

Altitude - 1000m

Environment Temperature - 40°C

CONTACTS:

UNIVERSAL MOTORS Tel: +351 252 299 080
 Rua de São Brás,745 Fax: +351 252 299 089
 4480-782 VILA DO CONDE Mail: geral@universalmotors.pt

* References applied only in the UK